

SUMMARY

Wires

Triax 1



Image is for illustrative purpose only

Series 0S
Termination type Female solder
IP rating 50
AWG wire size 0.00 - 0.00
Cable Ø 2.30 - 3.20 mm
Status active
Matching parts [ERA.0S.650.CTA](#)

Download

[Request a quote](#)

[Catalog](#)

TECHNICAL DETAILS

Mechanics

Shell Style/Model FFA*: Straight plug, cable collet and nut for fitting a bend relief
Keying Circular, female
Housing Material Brass (chrome plated [SAE AMS 2460]) shell and collet nut, nickel plated [SAE AMS QQ N 290] brass latch sleeve and mid pieces
Variant Z : Nut for fitting a bend relief
Weight 8.47 g

Performance

Configuration 0S.650 : 1 Triax (50 Ohm)
Insulator T: PTFE
Rated Current 6 Amps

Specifications

Contact Type: Triaxial 50 Ohm (Solder)
Contact Dia.: 0.9 mm (0.035" in)
Vtest: 1200 V (AC), 1700 V (DC)
Impedance: 50 Ohm
VSWR: 1.03 + 0.34 * f /GHz
Cable type: RGT 178, RGT 174

LEMO products and services are provided "as is". LEMO makes no warranties or representations with regard to LEMO product & services or use of them, express, implied or statutory, including for accuracy, completeness, or security. The user is fully responsible for his products and applications using LEMO components.

Others

Endurance (Shell): 5000 mating cycles
Temp (min / max): -55°C / +250°C
Humidity (max): ≤95% [at 60 deg C / 140 F]
Vibration: 15 g [10 Hz - 2000 Hz]
Shock Resistance: 100 g [6 ms]
Climatical Category: 50/175/21
Shielding (min): 75 dB (10 MHz)
Shielding (min): 40 dB (1 GHz)
Salt Spray Corrosion: >144 hr

DRAWINGS

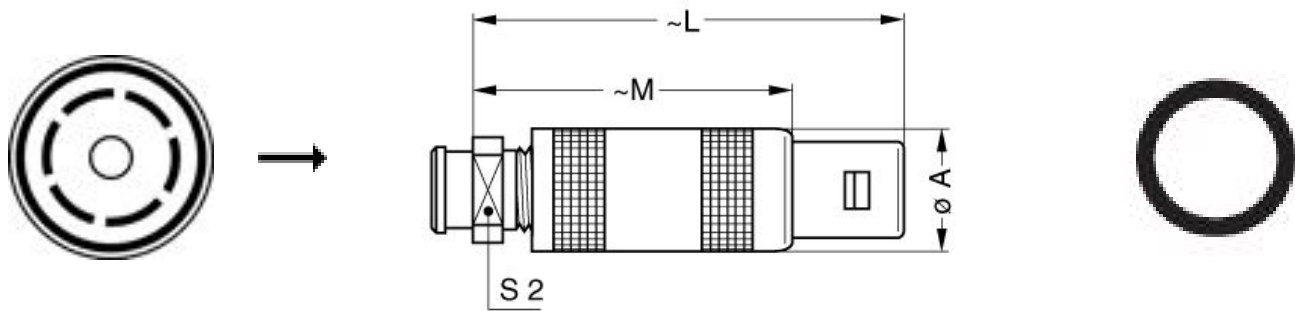

Dimensions

	A	L	M	S2
mm.	9	34.5	24.5	7
in.	0,35	1,36	0,96	0,28

RECOMMENDED BY LEMO

Tools

Spanner wrench: [DCD.0S.ZZZ.PA065](#)

LEMO products and services are provided "as is". LEMO makes no warranties or representations with regard to LEMO product & services or use of them, express, implied or statutory, including for accuracy, completeness, or security. The user is fully responsible for his products and applications using LEMO components.

LEMO products and services are provided "as is". LEMO makes no warranties or representations with regard to LEMO product & services or use of them, express, implied or statutory, including for accuracy, completeness, or security. The user is fully responsible for his products and applications using LEMO components.